



Wall-mounted room thermostat with LCD

RDG400

for VAV heating and cooling systems

- **Modulating PI control**
- **Control depending on the room or the return air temperature**
- **Output for DC 0...10 V actuator and auxiliary output On/Off, PWM or 3-position**
- **Automatic or manual heating/cooling changeover**
- **Operating modes: Comfort, Economy and Protection**
- **3 multifunctional inputs for keycard contact, external sensor, etc.**
- **Adjustable commissioning and control parameters**
- **Minimum and maximum setpoint limitation**
- **Minimum and maximum limitation of air flow signal DC 0...10 V**
- **Output signal inversion as an option**
- **Operating voltage AC 24 V**
- **Backlit display**

Use

The room thermostat is designed for the following types of system:

VAV systems via On/Off or modulating control outputs:







- Single-duct system
- Single-duct system with electric heater
- Single-duct system and radiator/floor heating
- Single-duct system with heating/cooling coil

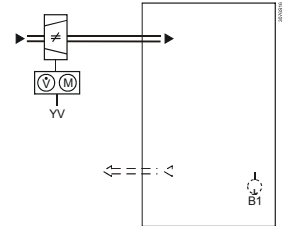

Functions

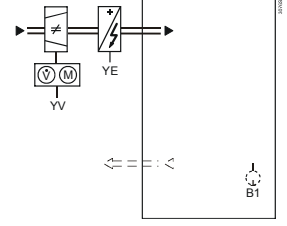
- Room temperature control via built-in temperature sensor or external room temperature/return air temperature sensor
- Automatic or manual changeover between heating and cooling mode
- Selection of applications via DIP switches
- Selection of operating mode with operating mode button on the thermostat
- Display of current room temperature or setpoint in °C and/or °F
- Minimum and maximum setpoint limitation
- Button lock (automatic or manual)
- 3 multifunctional inputs, freely selectable for:
 - Operating mode switchover contact (keycard, window contact, etc.)
 - Changeover sensor for automatic heating/cooling mode
 - External room temperature or return air temperature
 - Dewpoint sensor
 - Electric heater enable
 - Faults
- Minimum and maximum limitation of air flow signal DC 0...10 V
- Floor heating temperature limit
- Reload factory settings for commissioning and control parameters
- Wizard function to select working temperature unit °C or °F

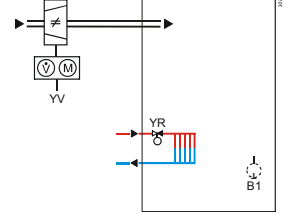
Applications

The thermostat supports the following applications, which can be configured via DIP switches at the rear of the unit. The control output for the damper actuator is either DC 0...10 V (factory setting) or 3-position (see parameter P47), and for the auxiliary heating/cooling output On/Off, PWM, 3-position or DC 0...10 V.

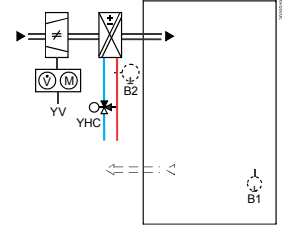
Application		DIP switches	Control output
Single-duct <ul style="list-style-type: none"> • DC 0...10 V damper actuator • 3-position damper actuator 			DC 0...10 V
			3-position
Single-duct with auxiliary heater <ul style="list-style-type: none"> • DC 0...10 V damper actuator and On/Off, PWM or 3-position auxiliary heater • 3-position damper actuator and DC 0...10 V auxiliary heater 			DC 0...10 V
			On/Off, PWM or 3-position
Single-duct and radiator/floor heating <ul style="list-style-type: none"> • DC 0...10 V damper actuator and On/Off, PWM or 3-position radiator • 3-position damper actuator and DC 0...10 V radiator 			DC 0...10 V
			On/Off, PWM or 3-position

Application		DIP switches	Control output
Single-duct heating and cooling coil <ul style="list-style-type: none"> DC 0...10 V damper actuator and On/Off, PWM or 3-position heating and cooling 3-position damper actuator and DC 0...10 V heating and cooling 			DC 0...10 V
			On/Off, PWM or 3-position











Type summary















Product no.	Operating voltage	Number of control outputs			
		On/Off	PWM	3-pos	DC 0...10 V
RDG400	AC 24 V	1 ¹⁾	1 ¹⁾	1 ¹⁾	1

¹⁾ On/Off, 3-position or PWM

Equipment combinations

DC 0...10 V actuator

Type of unit		Type reference	Data Sheet ^{*)}
Cable temperature sensor, cable length 2.5 m (8 feet) NTC (3 kΩ at 25 °C (77 °F))		QAH11.1	1840
Room temperature sensor NTC (3 kΩ at 25 °C (77 °F))		QAA32	1747
Cable temperature sensor, cable length 4 m (13 feet) NTC (3 kΩ at 25 °C (77 °F))		QAP1030/UFH	1854
Condensation detector/supply unit		QXA2000/ QX2000	1542
Electrical actuator, DC 0...10 V (for radiator valve)		SSA61..	4893
Electrical actuator, DC 0...10 V (for 2 and 3 port valves/V..P45)		SSC61..	4895
Electrical actuator, DC 0...10 V (for small valve 2.5 mm (0.1"))		SSP61..	4864
Electrical actuator, DC 0...10 V (for small valves 5.5 mm (0.2"))		SSB61..	4891
Electrical actuator, DC 0...10 V (for Combi-valve VPI45)		SSD61..	4861
Electromotoric actuator, DC 0...10 V (for valves 5.5 mm (0.2"))		SQS65..	4573

		GQD161..	4605	
		GDB161..	4634	
		GLB161..		
DC 0...10 V damper actuator		GMA161..	4614	
		GEB161..	4621	
		GCA161..	4613	
		GBB161..	4626	
		GIB161..		
VAV compact controller		GDB181.1E/3	3544	
		GLB181.1E/3		
On/Off actuators AC 24 V	Electromotoric On/Off valve and actuator (only available in AP, UAE, SA and IN)		MVI./MXI..	4867
	Electromotoric On/Off actuator		SFA71..	4863
	Thermal actuator (for radiator valve)		STA71..	4877
	Thermal actuator (for small valves 2.5 mm (0.1"))		STP71..	4878
3-position actuators AC 24 V	Electrical actuator, 3-position (for radiator valve)		SSA81..	4893
	Electrical actuator, 3-position (for small valve 2.5 mm (0.1"))		SSP81..	4864
	Electrical actuator, 3-position (for small valve 5.5 mm (0.2"))		SSB81..	4891
	Electrical actuator, 3-position (for Combi-valve VPI45)		SSD81..	4861
	Electromotoric actuator, 3-position (for valves 5.5 mm (0.2"))		SQS85..	4573

¹⁾ The documents can be downloaded from <http://siemens.com/bt/download>.

Accessories

Description	Product no.	Data Sheet ¹⁾
Changeover mounting kit (50 pcs/package)	ARG86.3	1840
Adapter plate 120 x 120 mm for 4" x 4" conduit boxes	ARG70	
Adapter plate 112 x 130 mm for surface wiring	ARG70.2	

¹⁾ The documents can be downloaded from <http://siemens.com/bt/download>.

Ordering

When ordering, please indicate product no. and description:

For example: **RDG400 room thermostat**

Order valve actuators separately.

Mechanical design

The room thermostat consists of two parts:

- Plastic housing which accommodates the electronics, the operating elements and the room temperature sensor
- Mounting plate with the screw terminals

The housing engages in the mounting plate and is secured with 2 screws.

Operation and settings

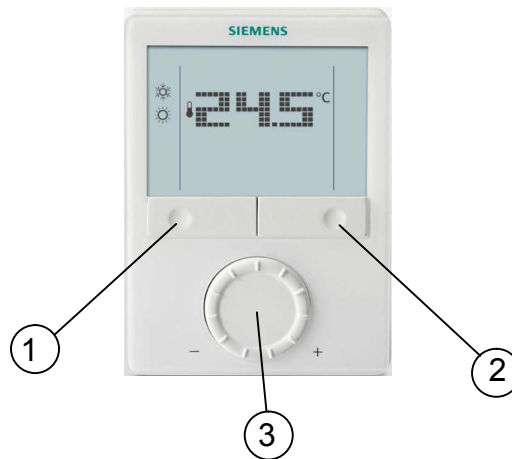

1. Operating mode selector/Esc
2. Protection and Ok
3. Rotary knob for setpoint and parameter adjustment

Display

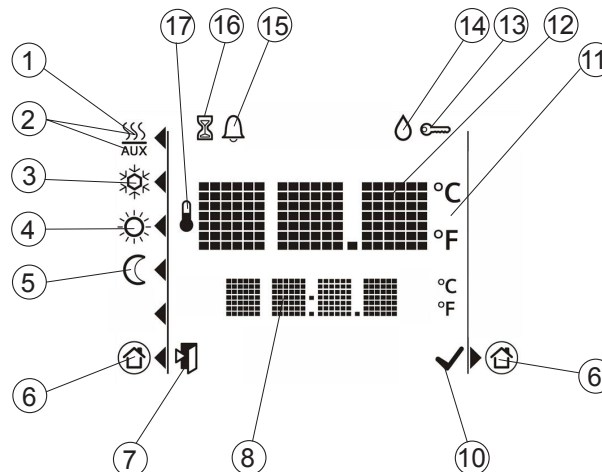

#	Symbol	Description	#	Symbol	Description
1		Heating mode	10		Confirmation of parameters
2		Heating mode auxiliary heater on (2 nd stage)	11		Degrees Celsius Degrees Fahrenheit
3		Cooling mode	12		Digits for room temperature and setpoint
4		Comfort mode	13		Button lock active
5		Economy mode	14		Condensation in room (dew point sensor active)
6		Protection	15		Fault
7		Escape	16		Temporary timer function (visible when operating mode is temporarily extended due to prolonged presence or absence)
8		Digits for room temperature, setpoint, etc.	17		Indicates that room temperature is displayed

Mounting and installation

Do not mount on a wall in niches or bookshelves, behind curtains, above or near heat sources, or exposed to direct solar radiation. Mount about 1.5 m (5 feet) above the floor.

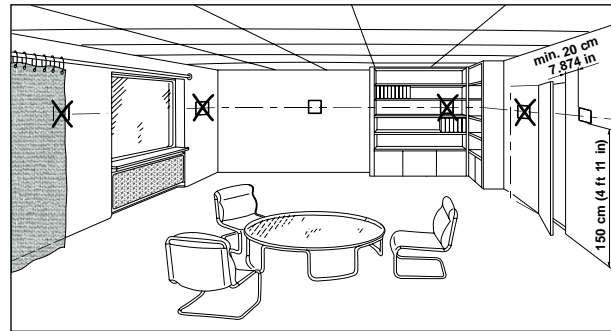

Mounting



- The room thermostat must be mounted in a clean, dry indoor place and must not be exposed to drip or splash water.

Wiring



See Mounting Instructions (M3182) enclosed with the thermostat.

- Comply with local regulations to wire, protect and earth the thermostat.

Warning!

No internal line protection for supply lines to external consumers (Y1, Y2)

Risk of fire and injury due to short-circuits!

- Adapt the line diameters as per local regulations to the rated value of the installed overcurrent protection device.
- The power supply line must have a circuit breaker with a rated current of no more than 10 A. For US installations use Class 2 rated power supplies.
- Inputs X1-M, X2-M or D1-GND of different units (e.g. summer/winter switch) may be connected in parallel with an external switch. Consider overall maximum contact sensing current for switch rating.
- Disconnect power supply before removing the thermostat from the mounting plate!



Commissioning

1. Select the application via the DIP switches at the rear of thermostat before fitting the front housing to the mounting plate.
2. Power up the thermostat after successfully connecting the line power. The thermostat starts to reset and all LCD segments flash, indicating that the reset is correct.

After the reset, which takes about 3 seconds, the thermostat is ready for commissioning by qualified HVAC staff. The control parameters of the thermostat can be adjusted to ensure optimum performance of the entire system (see Basic Documentation P3182).

Temperature unit selection wizard

The temperature unit selection wizard enables to select the preferable temperature unit display on thermostat between °C and °F.

1. Rotate rotary knob to select the preferable temperature unit.
2. Press the button ✓ (OK) to confirm the selection, and the thermostat goes to normal operating page.

Notes

- Pressing button ↵ (Esc) does not confirm the temperature unit selection.
- If the temperature unit is not selected, °C is used by default.

Control sequence

- The control sequence may need to be set via parameter P01 depending on the application. The factory setting for the single-duct application is "Cooling only".

Calibrate sensor

- Recalibrate the temperature sensor if the room temperature displayed on the thermostat does not match the room temperature measured. To do this, change parameter P05.

Setpoint and setpoint range limitation

- We recommend to review the setpoints and setpoint ranges (parameters P08...P12) and change them as needed to achieve maximum comfort and save energy.





Disposal



The device is considered an electronic device for disposal in terms of the European Directive 2012/19/EU and may not be disposed of as domestic garbage.

- Dispose of the device through channels provided for this purpose.
- Comply with all local and currently applicable laws and regulations.

Technical data

 Power supply	Operating voltage	SELV AC 24 V/DC 24 V or DC 24 V: connect G to + and G0 to -	SELV AC 24 V/DC 24 V or AC 24 V/DC 24 V class 2 (US)
	Frequency		50/60 Hz
	Power consumption		Max. 2 VA
	External supply line protection (EU)		Circuit breaker max. 10 A Characteristic B, C, D according to EN 60898 or Power source with current limitation of max. 10 A
	 <p>No internal fuse. External preliminary protection with max. C 10 A circuit breaker in the supply line required under all circumstances.</p>		
Outputs	Control output Y10-G0		DC 0...10 V
	Resolution		39 mV
	Current		Max. ±1 mA
Inputs	Control output Y1, Y2-G		AC 24 V
	Rating		15 mA...1 A
	Multifunctional inputs X1-M/X2-M		
	Temperature sensor input		
	Type		NTC (3 kΩ at 25 °C (77 °F))
	Digital input		
	Operating action		Selectable (NO/NC)
	Contact sensing		DC 0...5 V, max. 5 mA
	D1-GND		
	Operating action		Selectable (NO/NC)
	Contact sensing		SELV DC 6...15 V, 3...6 mA
Operational data	Function input		Selectable
	External temperature sensor, changeover sensor, operating mode switchover contact, dewpoint monitor contact, enable electric heater contact, fault contact		
	Switching differential, adjustable		
	Heating mode	(P30)	2 K (0.5...6 K) 4 °F (1...12 °F)
	Cooling mode	(P31)	1 K (0.5...6 K) 2 °F (1...12 °F)
	Setpoint setting and range		
	 Comfort mode	(P08)	21 °C (5...40 °C) 70 °F (41...104 °F)
	 Economy mode	(P11-P12)	15 °C (59 °F)/30 °C (86 °F) OFF, 5...40 °C (41...104 °F)
	 Protection	(P65-P66)	8 °C (46 °F)/OFF OFF, 5...40 °C (41...104 °F)
	Multifunctional inputs X1/X2/D1		Selectable
Input X1		Ext. temperature sensor (P38=1)	
Input X2		Changeover sensor (P40=2)	
Input D1		Operating mode switchover (P42=3)	

	Built-in room temperature sensor	
	Measuring range	0...49 °C (32...120 °F)
	Accuracy at 25 °C (77 °F)	< ± 0.5 K (± 1 °F)
	Temperature calibration range	± 3.0 K (± 6 °F)
	Settings and display resolution	
	Setpoints	0.5 °C (1 °F)
	Current temperature value displayed	0.5 °C (1 °F)
Environmental conditions	Operation	As per IEC 60721-3-3
	Climatic conditions	Class 3K5
	Temperature	0...50 °C (32...120 °F)
	Humidity	<95% r.h.
Standards	Transport	As per IEC 60721-3-2
	Climatic conditions	Class 2K3
	Temperature	-25... 60 °C (-13...140 °F)
	Humidity	<95% r.h.
Standards	Storage	As per IEC 60721-3-1
	Climatic conditions	Class 1K3
	Temperature	-25... 60 °C (-13...140 °F)
	Humidity	<95% r.h.
Standards	EU Conformity (CE)	CE1T3181xx ^{*)}
	RCM Conformity	CE1T3181en_C1 ^{*)}
	 UL	UL 916 PAZX CSA-C22.2 No. 205 PAZX7 http://database.ul.com
	Safety class	III as per EN 60730-1
Environmental compatibility	Pollution class	Normal
	Degree of protection of housing	IP30 as per EN 60529
	The product environmental declaration CE1E3181 ^{*)} contains data on environmentally compatible product design and assessments (RoHS compliance, materials composition, packaging, environmental benefit, disposal).	
Eco design and labelling directives	Based on EU Regulation 813/2013 (Eco design directive) and 811/2013 (Labelling directive) concerning space heaters, combination heaters, the following classes apply:	
	<ul style="list-style-type: none"> - Application with On / Off operation of a heater Class I value 1.0% - Modulating room thermostat, for use with modulating heaters Class V value 3.0% 	
General	Connection terminals	Solid wires or prepared stranded wires 1 x 0.4...2.5 mm ² (14 gauge) or 2 x 0.4...1.5 mm ² (16 gauge)
	Housing front color	RAL 9003 white
	Weight	0.350 kg

^{*)} The documents can be downloaded from <http://siemens.com/bt/download>.

Connection terminals

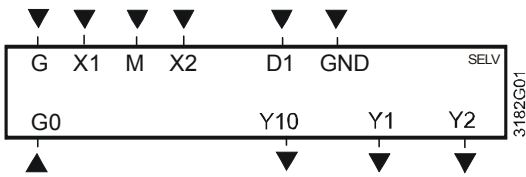

G, G0	Operating voltage AC 24 V
Y10/G0	Control output for DC 0...10 V actuator
Y1/G, Y2/G	Control output for On/Off, PWM or 3-position actuators
X1, X2	Multifunctional input for temperature sensor (e.g. QAH11.1) or potential-free switch Factory setting: - X1 = external room temperature sensor - X2 = sensor or switch for automatic heating/cooling changeover
M	Measuring neutral for sensor and switch
D1, GND	Multifunctional input for potential-free switch. Factory setting: Operating mode switchover contact

Connection diagrams

Application: Single-duct

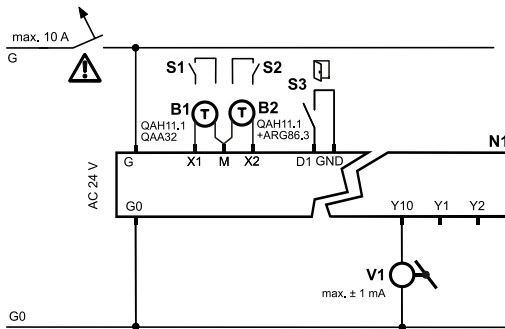

- V1 DC 0...10 V damper actuator
- N1 Room thermostat RDG400
- S1..S3 Switch (keycard, window contact, etc.)
- B1, B2 Temperature sensor (return air temperature, external room temperature, changeover sensor, etc.)

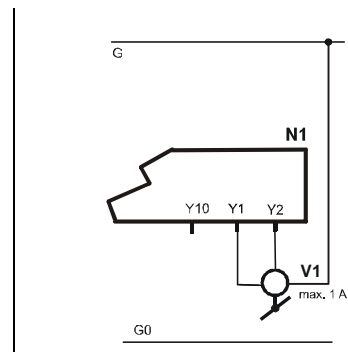

- V1 3-position damper actuator

Application: Single-duct with electric heater, radiator or heating/cooling valve

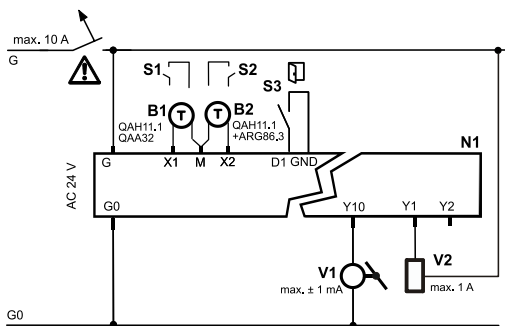

- V1 DC 0...10 V damper actuator
- V2 On/Off or PWM electric heater, radiator or heating/cooling valve
- N1 Room thermostat RDG400
- S1..S3 Switch (keycard, window contact, etc.)
- B1, B2 Temperature sensor (return air temperature, external room temperature, changeover sensor, etc.)

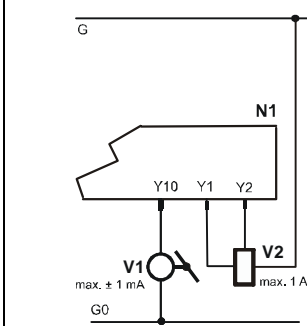

- V1 DC 0...10 V damper actuator
- V2 3-position electric heater, radiator or heating/cooling valve

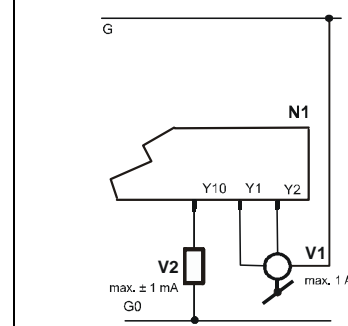

- V1 3-position damper actuator
- V2 DC 0...10 V electric heater, radiator or heating/cooling valve



For US installations, use Class 2 rated power supplies.
For other installations, use circuit breakers with rated current of no more than 10 A.

Dimensions

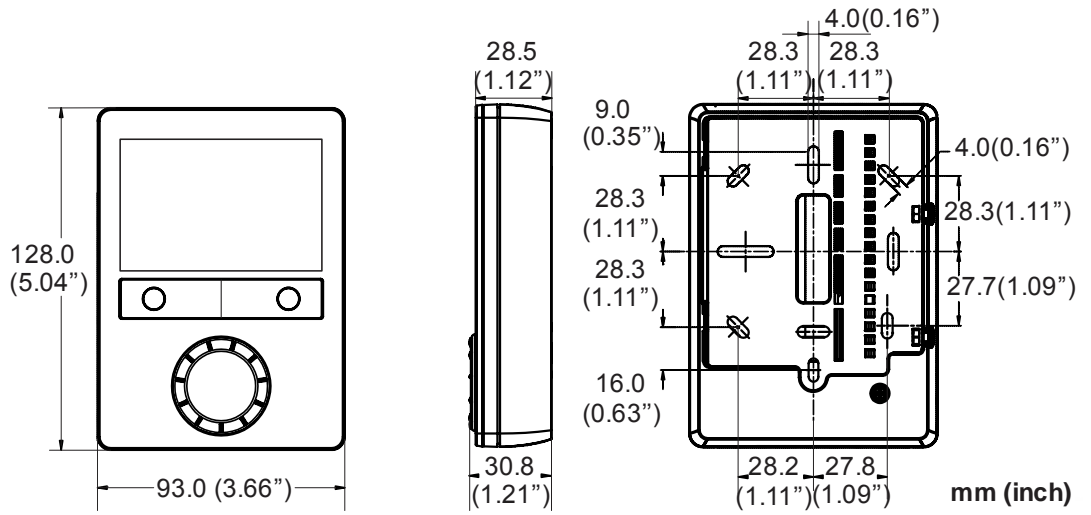

Issued by
Siemens Switzerland Ltd.
Building Technologies Division
International Headquarters
Gubelstrasse 22
CH-6300 Zug
Tel. +41 58-724 24 24
www.siemens.com/buildingtechnologies

© Siemens Switzerland Ltd, 2009 - 2017
Technical specifications and availability subject to change without notice.